



# Mass Spectrometers for Gas Analysis

## MASS SPECTROMETERS

# Systems for Gas Analysis Applications

A range of gas analysis systems: stable, sensitive and responsive for real-time analysis of multiple gas and vapour species with dynamic range from ppb to 100%.

Hidden Analytical have been designing and developing the highest quality quadrupole mass spectrometer based gas analysis systems over 35 years. We have built a reputation for delivering instruments with superior sensitivity, accuracy and reproducibility together with a first class global service and applications support network.

Hidden gas analysis systems provide for real-time analysis of almost any gas and vapour including: *ammonia, argon, butane, carbon dioxide, carbon monoxide, chlorine, deuterium, deuterated compounds, ethanol, fluorocarbons, helium, hydrocarbons, hydrogen, hydrogen chloride, hydrogen sulphide, krypton, methane, methanol, neon, nitric oxides, nitrogen, oxygen, propane, propene, sulphur oxides, VOCs, water, xenon ...*

Recent Advances in quadrupole mass spectrometry provide controllable field axis technology for:

- ▶ Soft ionisation for simplified analysis of complex spectra - ion source control enables precise control of ionisation and ion extraction parameters with accurate adjustment of electron energy through the critical range 0.4 eV up to 150 eV
- ▶ Reduced peak tails for high abundance sensitivity with triple-filter technology



# Contents



**QGA** - Quantitative Gas Analyser

## Gas Analysis Systems

**QGA** – Quantitative Gas Analyser

---

**HPR-20 R&D** – Gas Analysis System for Advanced Research

---

**ExQ COMPACT GAS ANALYSER** – for Less Demanding Applications

## Gas Sampling Inlet Options

**PRESSURE AND TEMPERATURE GAS SAMPLING OPTIONS**

## Application Specific Systems

**HPR-20 EGA** – Gas Analysis System for Evolved Gas Analysis in TGA-MS

---

**HPR-20 TMS** – Transient MS for Fast Event Gas Analysis

---

**SYSTEMS FOR SPECIALIST APPLICATIONS** – HPR-20 DLS, HPR-20 EPIC, HPR-20 S1000

---

**HPR-20 MULTI-STREAM SYSTEMS** – Gas Analysis Systems for Multi-stream Analysis

---

**HPR-40 DSA** – Membrane Inlet Mass Spectrometer for Dissolved Species Analysis

---

**HPR-40 DEMS** – for Differential Electrochemical Mass Spectrometry

---

**HPR-60 MBMS** – Molecular Beam Sampling Mass Spectrometer for Ion and Radical Analysis

---

**HPR-70** – Batch Inlet Gas Analysis System for Discrete Low Volume Sample Analysis

---

**HPR-90** – Automated Package Cracking Analysis System for Light Bulb Gas Analysis

---

**APPLICATION SOFTWARE** – QGA Professional, EGAssoft and MASsoft Professional



**HPR-20 EGA** - Gas Analysis System for Evolved Gas Analysis in TGA-MS



**HPR-40 DEMS** system

# QGA

## Quantitative Gas Analyser

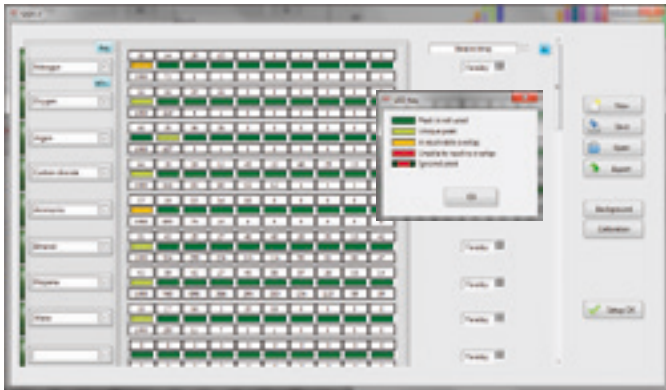

Automatic mass spectral calculator

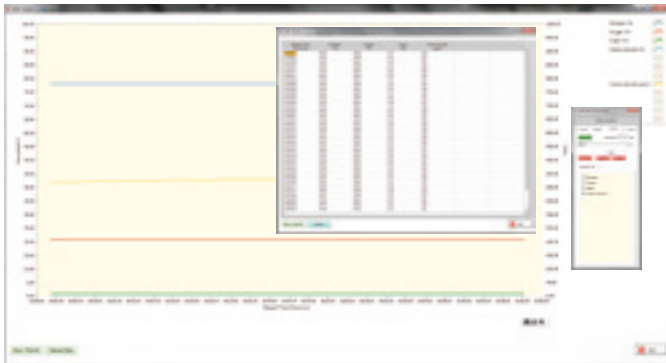

Graphical and tabular data with plot control

### FEATURES:

- ▶ simplified set up and operation from template files
- ▶ real-time graphical and tabular data displays
- ▶ automatic calibration with background correction
- ▶ species molecular weight range to 200 amu
- ▶ OPC data available as raw data or %/ppm quantitative output
- ▶ gas/vapour mass spectral library with intelligent scan feature for precise fragmentation pattern recording
- ▶ automatic subtraction of spectral overlaps

The Hidden QGA quantitative gas analysis system is for continuous analysis of multiple gases and vapours at pressures near atmosphere.

The Hidden QIC (Quartz Inert Capillary) sampling interface sampling from 100 mbar to 2 bar is included as standard. Operating to 200°C, the QIC flexible 2 m capillary inlet provides fast response times of less than 300 milliseconds for most common gases and vapours, including water and organic vapours.

The QGA system has a mass range of 200 amu (300 amu option) and a detection capability from 100% to less than 100 parts per billion.

The QGA system connects to a range of backing pump options including a high performance scroll pump. For flexibility the QGA will operate with foreline connection up to 10 m.



QGA - benchtop gas analyser



EXTERNAL SCROLL PUMP

# HPR-20 R&D

## for Advanced Research

The Hiden HPR-20 R&D specialist gas analysis system is a benchtop mass spectrometer for the monitoring of evolved gases and vapours. A triple filter mass spectrometer is included providing improved resolution and abundance sensitivity with an ultimate detection limit of 5 ppb subject to spectral interference.

The HPR-20 R&D is offered with a wide range of interfaces for connection to external equipment and is configured with Hiden's heated Quartz Inert Capillary (QIC) for continuous sampling of gases and vapours.

Backing and bypass pumping is provided by a high performance scroll pump. Gas sampling is continuous with a gas sample flow rate user configurable in the range < 1 ml/min to > 15 ml/min.



HPR-20 R&D

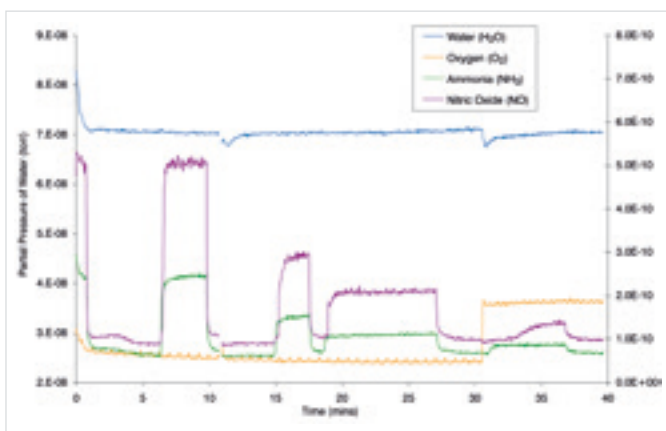

Simultaneous measurement of low ppm levels of ammonia, nitric oxide and oxygen in percentage (2%) concentrations of water

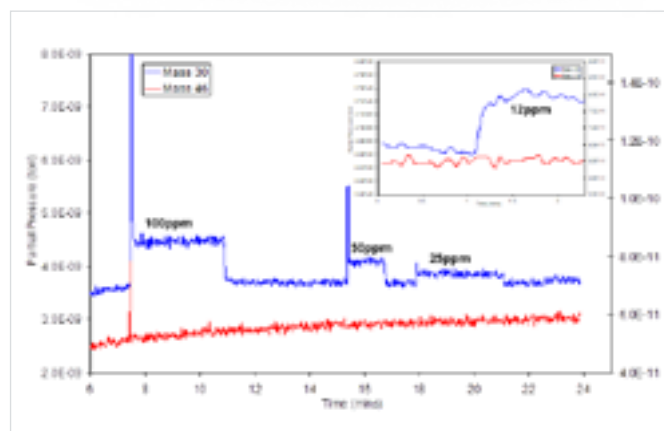

Detection Limit of NO in 1000 ppm NO<sub>2</sub> (Inset: Expansion of detection of 12 ppm NO in 1000 ppm NO<sub>2</sub>). Primary Axis represents Partial Pressure at m/z 30, Secondary Axis represents Partial Pressure at m/z 64

### FEATURES:

- ▶ triple filter mass spectrometer
- ▶ mass range options: 200, 300 or 510 amu
- ▶ enhanced abundance sensitivity
- ▶ detection to 5 ppb
- ▶ APSI-MS soft ionisation mode

# ExQ COMPACT GAS ANALYSER

## for less demanding applications



ExQ – compact gas analyser



ExQ<sup>RM</sup> – rack mount gas analyser

The Hiden Compact Gas Analyser is configured for continuous analysis of gases and vapours at pressures near atmosphere in standard form. Inlet accessories are available to configure the system for sampling from low to high pressures, up to 30 bar. The system is available as a benchtop mounted system, or in a 19-inch rack mountable system package.

The Hiden QIC (quartz inert capillary) sampling interface sampling from 100 mbar to 2 bar is included as standard. Operating to 200°C, the QIC flexible 2 m capillary inlet provides fast response times of less than 300 milliseconds for most common gases and vapours, including water and organic vapours.

The ExQ system includes an internal membrane pump to provide combined sample bypass and UHV foreline pumping. The ExQ system has a mass range of 200 amu (300 amu option) and a detection capability from 100% to less than 100 parts per billion.

### FEATURES:

- ▶ quantitative data output and data export
- ▶ 300 ms response time to changes in gas concentrations
- ▶ gas/vapour mass spectral library with intelligent scan feature for precise fragmentation pattern recording
- ▶ automatic subtraction of spectral overlaps
- ▶ APSI-MS soft ionisation mode
- ▶ low dead volume, heated inlet for fast response to vapours

## GAS SAMPLING INLET OPTIONS

# Pressure and Temperature Gas Sampling Options

Hiden offer a variety of inlet options for the gas analysis systems. Capillary inlets are available to sample at pressures both above and below atmospheric pressure. High pressure inlets are offered for sampling gases and vapours up to 30 bar, and special capillaries are offered for low pressure sampling down to 1 mbar. There is also a high temperature version of the QIC Inlet available for demanding applications.

Other options include heated capillary extensions, heated multi-stream inlets and hot-zone adaptors for sampling from furnaces (for example TGA-MS).



Twin Capillary QIC Inlet  
- Dual Capillary system with  
fast switching valve



Proteus 40-way and 80-way rotary valve



Micro-flow capillary inlet. Sampling rate 12 µl/min.  
Single or multi-capillary inlet option



HT/HP inlet (up to 30 bar at 200°C)

### FEATURES:

- ▶ high temperature capillary inlet
- ▶ high pressure/high temperature sampler
- ▶ low pressure capillaries
- ▶ micro-flow capillary inlet
- ▶ heated capillary extension
- ▶ hot-zone inlets
- ▶ multi-stream selectors - 8, 16, 20, 40 and 80-way
- ▶ flexible RGA inlet for residual gas analysis at high vacuum

## HPR-20 EGA

# for Evolved Gas Analysis in TGA-MS



HPR-20 EGA

The Hiden HPR-20 EGA gas analysis system is configured for continuous analysis of evolved gases and vapours from thermogravimetric analysers (TGA). Interface systems are available for most TGA instruments. The TGA interface includes re-entrant furnace sampling, providing close coupling to the TGA furnace region for optimized evolved gas/vapour analysis.

Custom designed interfaces are available for special requirements with alternative systems being offered for applications requiring direct sampling from advanced thermogravimetric analysers operating at higher pressures to 30 bar.

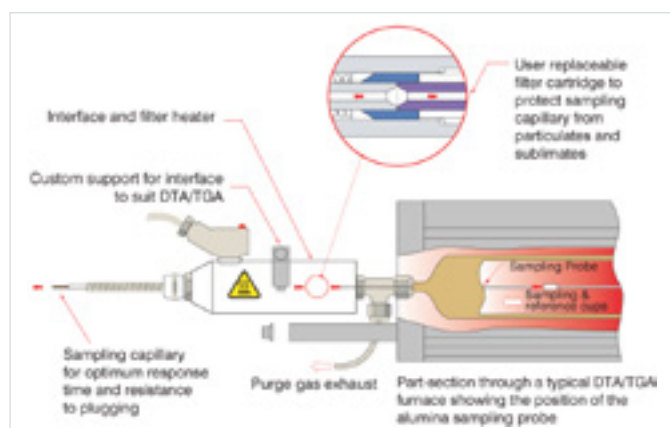

Typical TGA inlet

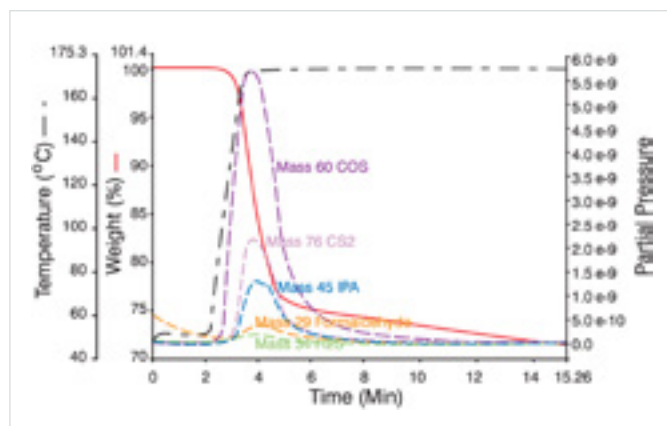

TGA-MS plot

### FEATURES:

- ▶ enhanced pumping for light gases
- ▶ heated inlet for non-tailing response to desorbed gases and vapours
- ▶ control of ionisation energy parameters for simplification of cracking patterns
- ▶ custom, low dead volume interface to specific manufacturers' TGA systems
- ▶ optimised data acquisition using EGAsoft
- ▶ mass range option 200 or 300 amu



Fast response, low dead volume interfaces are offered for the most popular TGA equipment.

Each interface has been custom engineered in collaboration with TGA manufacturers and includes, where necessary, robust clamping arrangements and an in-line heated filter assembly between the outlet of the TGA and the MS capillary inlet.



# HPR-20 TMS

## Transient MS for Fast Event Gas Analysis



HPR-20 TMS transient MS QIC inlet

The Hiden HPR-20 TMS Transient MS is configured for fast event analysis of gases and vapours at pressures near atmosphere. Ideal for fast gas switching experiments, the MS features the Hiden QIC quartz-lined 0.9 m sampling interface. The inlet, operating at 200°C, provides response times of less than 150 ms to changes in gas composition with a 5 decade response time in < 100 ms.

The QIC inlet is coupled directly to Hiden's Pulse Ion Counting (PIC) digital MS which is capable of measurement speeds of up to 500 data points/s over the entire 7 decade dynamic range.

Suited to fast data acquisition in the measurement of gas and vapour compositions in the sub ppm to low % concentration range.



HPR-20 transient MS data - > 5 decades response in < 100 ms

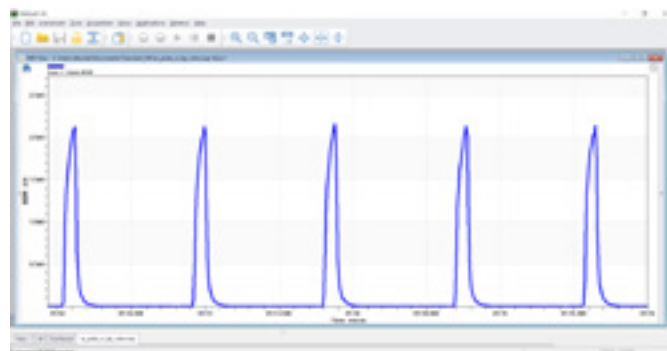

Analysis of fast gas pulsing experiments

### FEATURES:

- ▶ 0.9 m fast response QIC capillary - 150 ms response time
- ▶ open ion source and optimised pumping configuration for fast response
- ▶ digital PIC detector - 7 decades continuous dynamic range
- ▶ detection of low ppm to high % levels in < 100 ms
- ▶ fast scan speeds, 500 amu/s for transient analysis

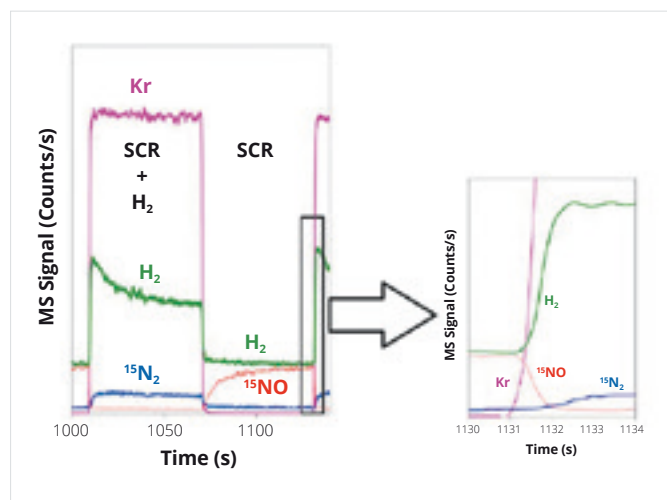

Mass spectrometer response for <sup>15</sup>N<sub>2</sub>, <sup>15</sup>NO, H<sub>2</sub> and Kr when switching 0.72% H<sub>2</sub> in and out of a SCR (NO<sub>x</sub> with octane) feed stream over a catalyst at 300 °C (J. P. Breen, R. Burch, C. Hardacre, C. J. Hill and C. Rioche, J. Catal., 2007, 246, 1-9).

# HPR-20 RANGE

## for Specialist Applications

The specialist range of Hiden HPR-20 gas analysis systems are configured for continuous analysis of gases and vapours at pressures near atmosphere in standard form, with alternative inlet systems being offered for applications requiring direct sampling from higher pressures to 30 bar.

The Hiden QIC quartz-lined sampling interface operating at 200°C provides fast response times of less than 300 milliseconds for most common gases and vapours, including water vapour.

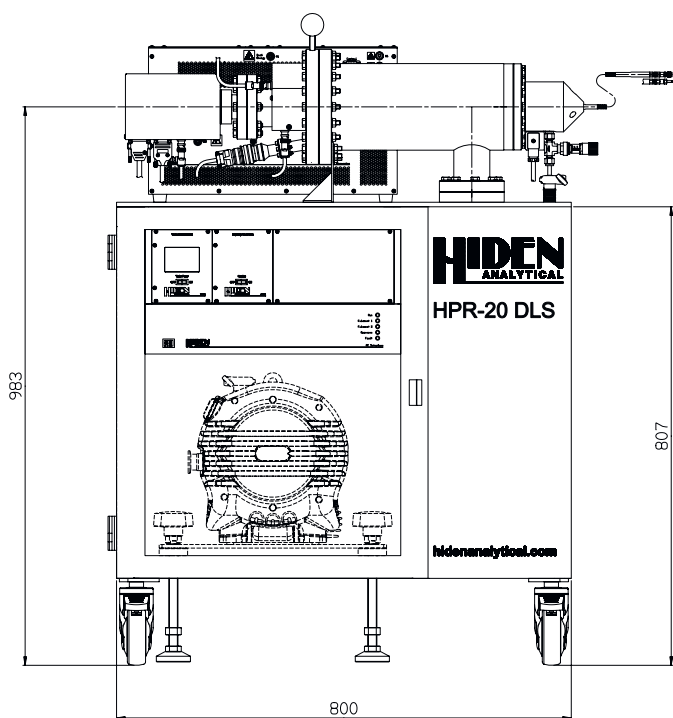

HPR-20 DLS system layout drawing

### FEATURES:

- ▶ high mass ranges
- ▶ ultra-high resolution
- ▶ negative ion detection with electron attachment

### HPR-20 DLS

for Ultra-High Resolution & Sensitivity Analysis of Hydrogen Isotopes and Light Gases

The HPR-20 DLS includes Hiden's DLS-20 triple filter quadrupole mass spectrometer with 20 mm pole diameter.

The DLS-20 includes unique, user switchable resolution modes allowing the DLS-20 quadrupole mass spectrometer to operate in dual quadrupole stability regions (Zones I and H) offering ultra-high resolution in the mass range to 20 amu (zone H) and very high-resolution performance up to 200 amu (Zone I).

### HPR-20 EPIC

with Electron Impact/Electron Attachment Ionization Modes

The system includes the Hiden EPIC triple filter mass spectrometer including a high gain pulse ion counting electron multiplier detector with positive and negative ion detection. Analysis is both by standard electron impact ionization and by appearance potential soft ionisation (APSI-MS).

The system includes a software selectable mode, electron attachment mass spectrometry (EA-MS), to analyse negative ions formed within the internal ioniser by electron attachment. The electron attachment mode provides vital information for investigating electronegative species, identifying the parent molecules of stable radicals from plasma processes for example.

### HPR-20 S1000

with 1000 amu mass range

The standard HPR-20 S1000 system includes the Hiden 3F series 1000 amu mass range triple filter quadrupole mass spectrometer with dual Faraday and pulse ion counting electron multiplier detectors. Detection capability is to less than 5 parts per billion.

A dry scroll pump is included to provide high performance combined sample bypass and UHV foreline pumping. This provides optimum performance for applications with a significant concentration of light gases, such as helium carrier gas.

# HPR-20 MULTI-STREAM SYSTEMS

## Gas Analysis Systems for Multi-stream Analysis

### MULTI-STREAM SAMPLING CAPABILITY IS OFFERED IN TWO VERSIONS:

- ▶ Laboratory scale multi-stream valve, MSV series for analysis of up to 8 sample lines
- ▶ Process analysis multi-stream Proteus valve for sampling up to 80 sample lines

Sampling systems are configured for continuous flow for all lines as standard providing fresh sample for analysis with a minimum sample purge time. Compatible for connection with the QIC capillary inlet.

Automatic operation allows for the data to be collected and displayed stream by-stream. Stream switching, data acquisition and flush timing are user controllable in software.

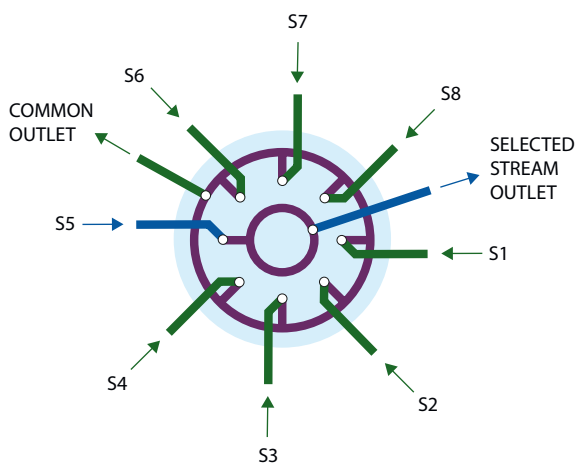

8-way multi-stream valve



Proteus multi-stream selector

### SPECIAL SYSTEM CONFIGURATIONS ARE OFFERED FOR FERMENTATION OFF-GAS ANALYSIS:

#### QIC BioStream systems

The QIC BioStream includes application specific process analysis software including OPC server technology, calculation of OUR (oxygen uptake rate), CER (carbon dioxide expiration rate) and RQ (respiratory quotient). Special options include an integrated selected sample stream flow meter to enable accurate analysis of the key fermentation parameters. The OPC server technology makes data transfer of the concentration of multiple gases on multiple streams together with derived parameters for each stream straightforward.



QIC BioStream-C - benchtop system



QIC BioStream system - mobile cart

# HPR-40 DSA

## for Dissolved Species Analysis



HPR-40 DSA

The Hiden HPR-40 DSA Membrane Inlet Mass Spectrometer (MIMS) is a compact benchtop gas analysis system for real-time quantitative analysis and monitoring of dissolved/evolved gases.

The system offers the facility for analysis to sub-ppb (parts per billion) levels and is suited to gas analysis applications where sample volume is small and for environmental applications where detection of a low concentration level is required. Many different interchangeable membrane inlet probes are available to address a broad range of applications.

The inlet probe uses a gas permeable membrane that allows dissolved gas/vapour molecules to pass through it and into the ion source of a high precision quadrupole mass spectrometer.

A manual isolation valve allows for control of the sampling and a solenoid safety valve provides protection for the mass spectrometer and vacuum system in case of membrane failure.



Cuvette inlet - for biofuel research

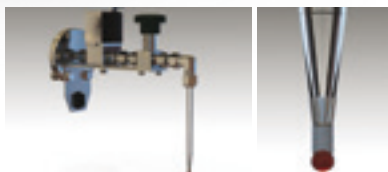

Enzyme Kinetics Probe - Real time mass spectrometry for enzyme kinetics studies



Interchangeable membrane inlet probe types

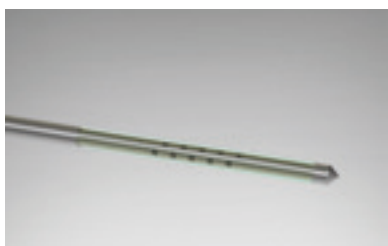

### FEATURES:

- ▶ analysis of dissolved species with mass range to 200 amu (300 amu option)
- ▶ sub parts per billion detection levels
- ▶ high precision and stability species ratio measurements (e.g. marine de-nitrification studies)
- ▶ soil core analysis
- ▶ fermentation process analysis
- ▶ water analysis in estuary, river or reservoir
- ▶ groundwater contamination studies
- ▶ methane production control
- ▶ microbiological/enzyme activity studies
- ▶ environmental monitoring

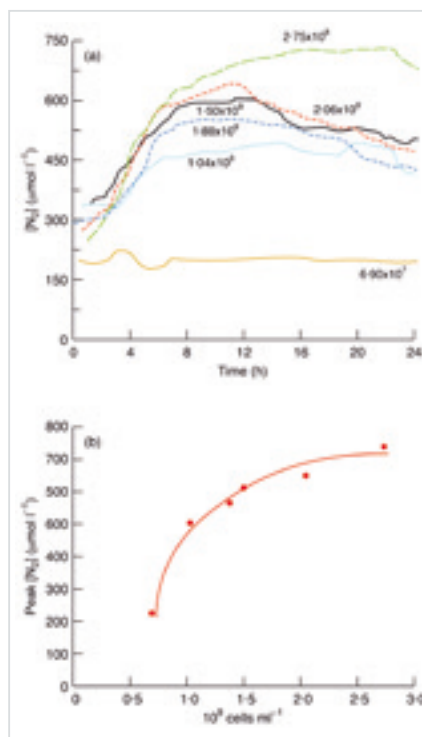

Denitrification by *Pseudomonas stutzeri* in a sterile lake water microcosm supplemented with succinate and nitrate  
JR Firth and C Edwards  
2000 *Journal of Applied Microbiology* **88** 853-859

## HPR-40 DEMS

# for Differential Electrochemical Mass Spectrometer

The Hiden HPR-40 DEMS is a bench mounted or mobile cart mounted module for analysis of dissolved species in electrochemistry. The system is modular and adaptable. The system includes two differential electrochemical mass spectrometry 'DEMS' cell inlets, designed for material/catalysis studies (cell type A), and electrochemical reaction studies (cell type B).

For applications where Online Electrochemical MS (OEMS) from an existing cell or reactor is required a range of standard inlet options is available offering both evolved off-gas and dissolved species analysis solutions. The HPR-40 DEMS system has a mass range of 200 amu (300 amu option) and sub ppm detection levels.



HPR-40 DEMS system



Cell type A

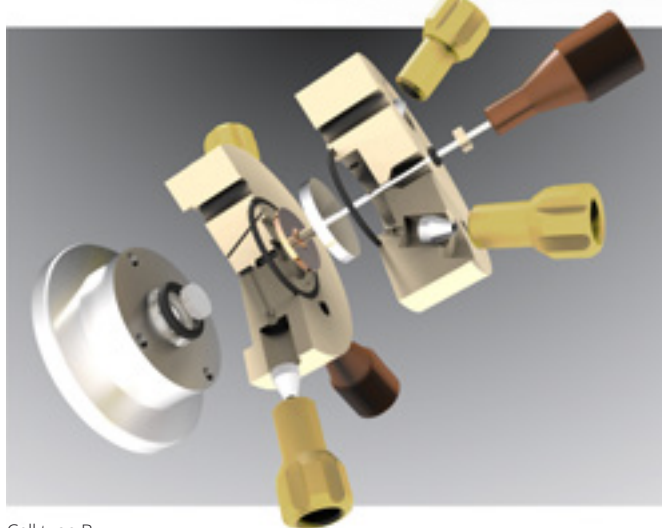

Cell type B

### FEATURES:

- ▶ Compact benchtop mass spectrometer system
- ▶ Mass scanning, and time/intensity trend monitoring of multiple species
- ▶ Modular, user configurable system including DEMS cell
- ▶ Fast response (< 1 second), nano-porous electrolyte/MS interface
- ▶ DEMS off-gas analysis capillary sampling option with micro-flow inlet
- ▶ Mass range: 200 amu is standard. 300 amu option

# HPR-60 MBMS

## for Ion and Radical Analysis

The Hiden HPR-60 molecular beam mass spectrometer is a compact skimmer inlet MS for the analysis of reactive gas phase intermediates. Radicals are sampled via a multistage differentially pumped skimmer inlet and transferred to the MS ion source with minimal interaction with other species and without wall collisions. Customisable inlets allow connection to many different reactor systems, including atmospheric plasmas.

The skimmer system, combined with a Hiden triple filter precision mass spectrometer, offers a sampling system with ultra fast response and high accuracy.

- ▶ catalytic reactors
- ▶ reaction kinetics
- ▶ study of transients
- ▶ plasma chemistry

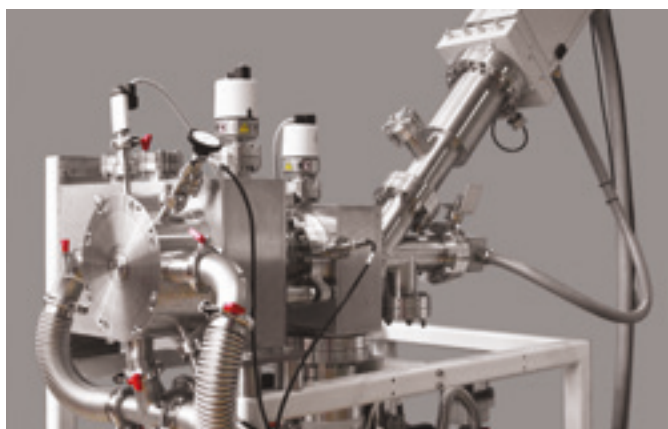

HPR-60 MBMS

### FEATURES:

- ▶ molecular beam sampling at atmospheric pressure
- ▶ +ve and -ve ion analysis
- ▶ user replaceable skimmer cones (can be biased)
- ▶ electron attachment ionisation mode for the study of electro-negative radicals
- ▶ APSI-MS soft ionisation mode for radicals analysis
- ▶ mass range options: 300, 510 or 1000 amu
- ▶ energy range options: 100 eV or 1000 eV

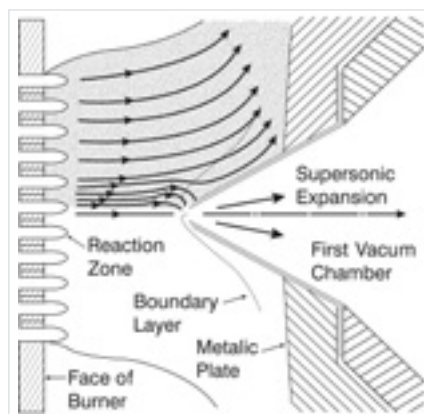

HPR-60 MBMS schematic

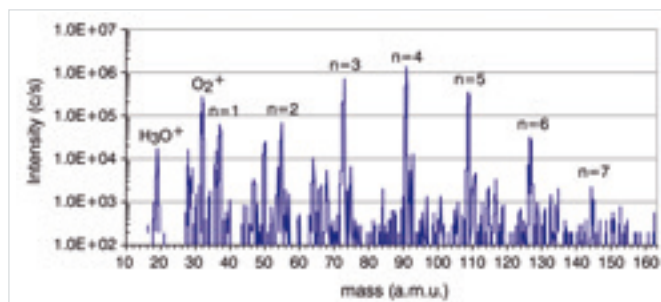

Hydrated cluster ions from atmospheric dielectric barrier discharge

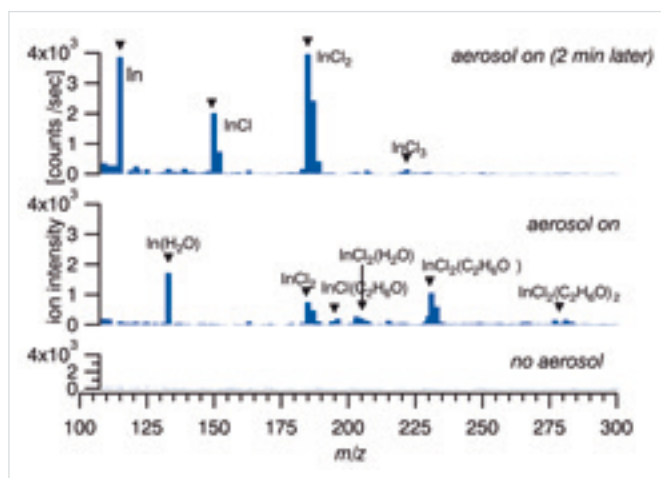

Mass spectra of the indium containing fractions of the aerosol of  $\text{InCl}_3$  in ethanol sprayed at room temperature. The lowest row is the background measurement in the chamber before aerosol generation. The middle spectrum is directly recorded as the aerosol is switched on and the top spectrum is measured after 2 min of spraying into a tube held at room temperature.

S Gledhill *et al.* 2011 *Thin Solid Films* **519** 6413-6419

# HPR-70

## for Discrete Low Volume Sample Analysis

The Hiden HPR-70 compact benchtop batch inlet gas analysis system is suitable for the analysis of discrete gas samples.

A small quantity of gas, usually at or close to atmospheric pressure, is sampled using an automated batch inlet. After expansion and consequent pressure drop the gas is analysed using a high sensitivity 500 amu quadrupole mass spectrometer.

Most minor components in the gas mixture can be measured at ppm levels.

- ▶ landfill and environmental monitoring
- ▶ nuclear gas analysis
- ▶ head space measurements
- ▶ fuel cell analysis
- ▶ geological samples

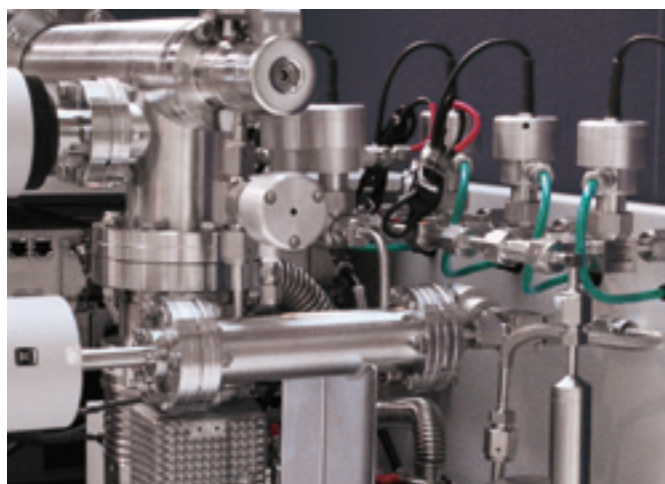

HPR-70 batch inlet

Parameter	Scan	Argon 40	Hydrogen 2	Water 18	NO.CO.28	Oxygen 32	CO2 44	Ar 1.04	H2 ppm 0.4	H2O ppm 0.4	NO.CO ppm 0.4	O2 ppm 0.4	CO2 ppm 0.4
00:12:340	2.357E-05	8.721E-05	2.019E-05	1.520E-05	4.139E-11	3.652E-10	9.925E-01	1.029E-02	1.317E-02	7.652E-02	1.340E-01	1.527E-02	
00:23:478	3.880E-05	8.803E-05	2.077E-05	1.733E-05	4.137E-11	3.286E-10	9.284E-01	1.040E-02	1.969E-02	4.270E-02	7.262E-02	8.000E-01	
00:34:815	3.357E-05	8.618E-05	2.110E-05	1.790E-05	4.274E-11	3.486E-10	9.384E-01	1.008E-02	2.897E-02	4.300E-02	7.282E-02	8.790E-01	
00:45:145	3.302E-05	8.524E-05	2.039E-05	1.629E-05	4.094E-11	3.918E-10	9.389E-01	9.826E-02	8.713E-02	4.070E-02	7.980E-02	9.343E-01	
00:56:843	3.372E-05	8.452E-05	2.120E-05	1.878E-05	4.287E-11	3.042E-10	9.895E-01	8.775E-02	2.702E-02	4.058E-02	7.952E-02	9.042E-01	
01:08:003	3.888E-05	8.328E-05	2.048E-05	1.794E-05	4.262E-11	3.810E-10	9.895E-01	8.462E-02	1.188E-02	4.242E-02	8.002E-02	9.889E-01	
01:19:122	3.912E-05	8.308E-05	1.839E-05	1.839E-05	4.042E-11	3.319E-10	9.389E-01	9.390E-02	-2.771E-02	4.114E-02	7.802E-02	9.389E-01	
01:30:258	3.824E-05	8.178E-05	2.040E-05	1.764E-05	4.240E-11	3.494E-10	9.389E-01	9.232E-02	1.128E-02	4.278E-02	7.888E-02	8.893E-01	

HPR-70 batch inlet sampling schematic

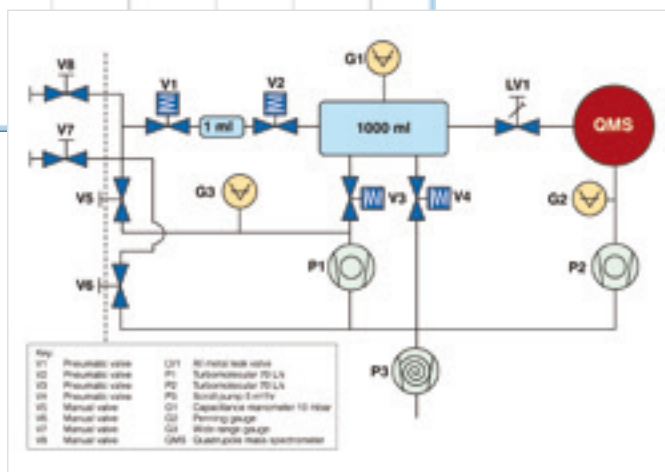

### FEATURES:

- ▶ dual compound turbo pumps and oil-free, totally dry backing pump
- ▶ automatic dosing, expansion and accurate sampling
- ▶ total sample pressure measurement with capacitance manometer
- ▶ optional aliquot filling facility
- ▶ 1 litre sample reservoir
- ▶ 1 ml injection reservoir
- ▶ optional calibration lines

# HPR-90

## for Light Bulb Gas Analysis

The HPR-90 automated package cracking analysis system is a complete system optimised to analyse gas within sealed volumes such as light bulbs. The HPR-90 system can be custom configured to suit small automobile bulbs through to fluorescent tubes.

This system comprises a piercing unit, UHV manifold and sampling system, a triple filter quadrupole mass spectrometer and all associated control equipment on a mobile cart.

- ▶ **fill gas analysis**
- ▶ **quality control studies**
- ▶ **sealed volumes analysis**
- ▶ **automatic data reporting formats**

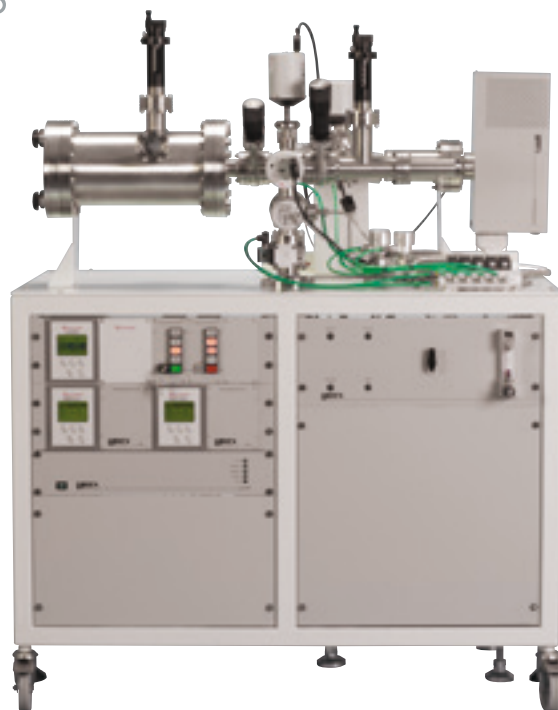

**HPR-90** automated package cracking analysis system

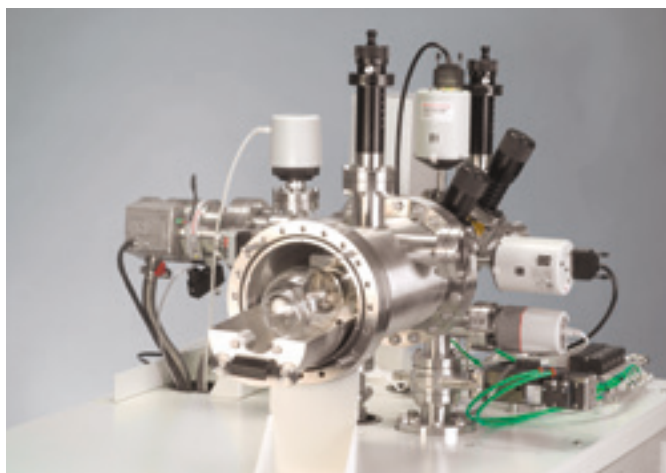

**HPR-90** carrier with light bulb

### FEATURES:

- ▶ Hiden HAL 3F/301 triple filter quadrupole mass spectrometer
- ▶ interchangeable cracking chamber with cracking mechanism
- ▶ automated inlet with automatic leak valve including calibration gas inlet
- ▶ high sensitivity to < 10 ppm in a sealed package at 10 mbar
- ▶ data can be collated with serial numbers from sample bulbs
- ▶ mass range options to 1000 amu
- ▶ automatic data reporting formats



# QGA PROFESSIONAL SOFTWARE

## for Quantitative Gas and Vapour Analysis



QGA PROFESSIONAL main screen

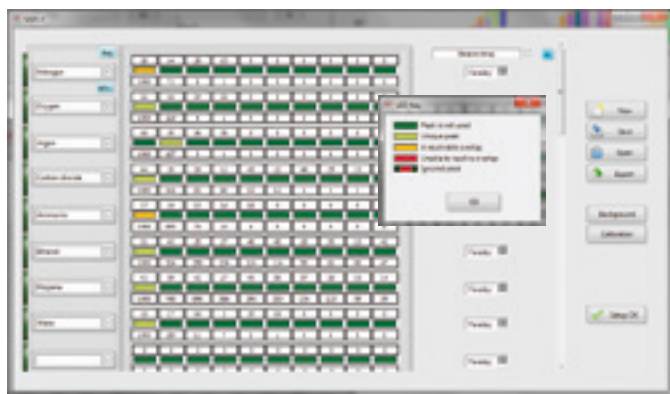

QGA PROFESSIONAL automatic mass spectral analysis setup

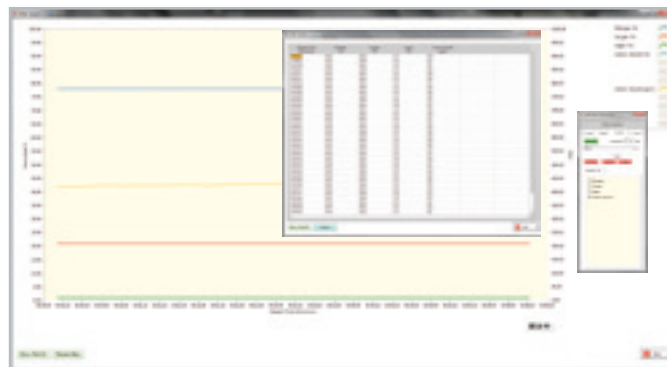

QGA PROFESSIONAL graphical and tabular data with plot control

QGA Professional software is an application specific software package for quantitative gas and vapour analysis providing real-time continuous analysis of up to 32 species with species concentration measured in the range 0.1 ppm to 100%. The software can be used in either single stream mode or multi-stream mode for use with multi-stream gas selection valves with up to 80 streams.

The software features easy-to-use calibration routines for both cracking pattern and Relative Sensitivity (RS) measurement. Analysis is performed using simple template setup routines and features automatic spectral removal algorithms and correction factor determination to output quantitative data. Integrated inputs from external devices such as CO analysers make the software versatile for a whole range of gas analysis applications.

### FEATURES:

- ▶ quantitative gas analysis of up to 32 gases
- ▶ 10 peak spectral library with intelligent library scan feature
- ▶ component gas calibration with background correction
- ▶ automatic triggering of analysis from an external input
- ▶ read multiple inputs, temperature or pressure for example
- ▶ x-axis can display time or an external input, e.g. temperature

# EGAsoft SOFTWARE

## for Evolved Gas Analysis

Hidden EGAsoft for evolved gas analysis data acquisition and analysis. Designed to simplify evolved gas analysis from devices such as thermogravimetric analysers (TGA), the software minimises the number of settings that are required, making it easy to use for even novice users. The 3D graphing of bar scan data ensures that trends can be easily identified from the decomposition of unknown substances while the Multiple Ion Detection (MID) mode allows desorption trends over time/temperature to be displayed.

Hidden collaborates with a range of TGA manufacturers to ensure the compatibility of the file export functions with their software. Unknowns can also be identified using the NIST export function.

In addition to the acquisition features the software also features some post process analysis functions such as peak integration and peak deconvolution with multiple Gaussian peaks. Data smoothing and anomalous data point removal features are also available.

- ▶ TGA-MS
- ▶ Temperature Programmed Desorption (TPD)
- ▶ Thermal Decomposition

### FEATURES:

- ▶ 3D bar scan view for easy determination of trends in bar data
- ▶ simple automatic export in formats specific for import to any TGA/STA manufacturer's software
- ▶ automatic spectral deconvolution in MID mode
- ▶ peak integration and data analysis routines
- ▶ auto-sequencing of MS data acquisition files e.g. for use with auto samplers
- ▶ auto start/stop and temperature inputs where output signals are available
- ▶ mass spectrometer ionisation energy control for soft ionisation of complex mixtures

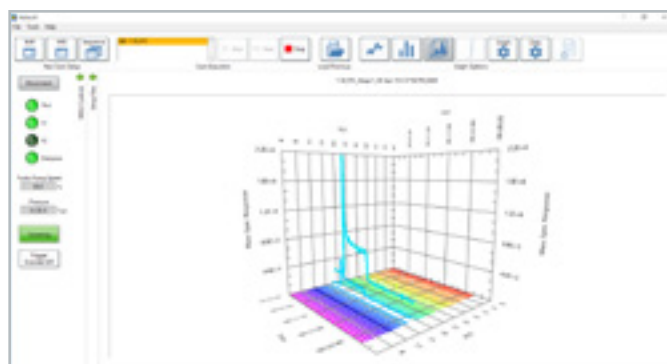

EGAsoft 3D bar mode

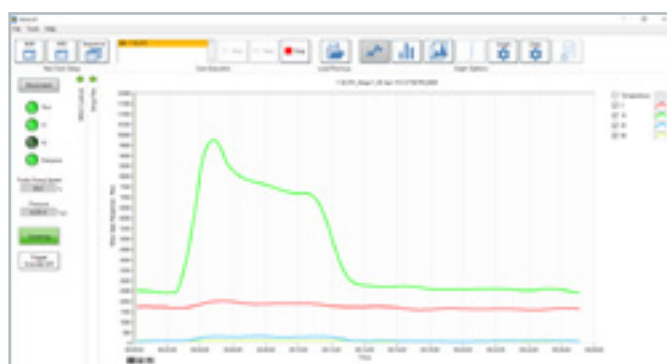

EGAsoft MID view



EGAsoft 2D bar mode

# MASsoft PROFESSIONAL

## Control Software

All Hiden instruments are supplied with MASsoft Professional mass spectrometer control software. MASsoft Professional is a multilevel software package allowing both simple control of mass spectrometer parameters and complex manipulation of data and control of external devices.

Quick start tabs with user configurable single key start functions means novice users can start collecting data within seconds.

Scan templates allow fast set up of scans from previous similar experiments.

User selected alarm facilities (including status indication with message send and output drive capability) provide powerful control for process environments.

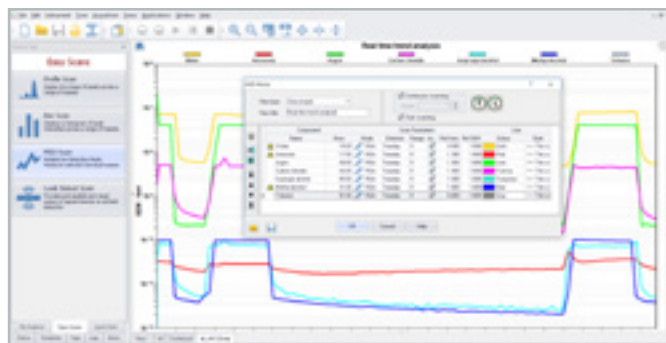

MASsoft PROFESSIONAL trend analysis (MID) setup

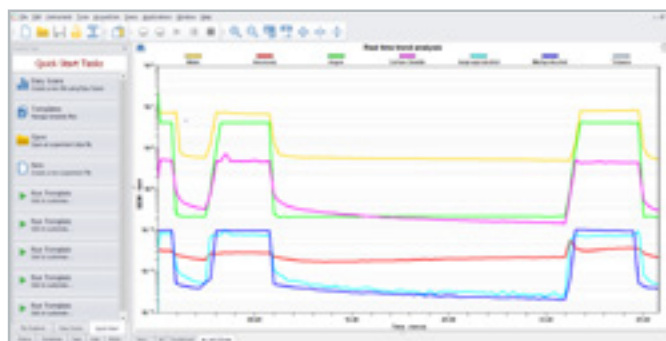

MASsoft PROFESSIONAL scan gallery



MASsoft PROFESSIONAL overview

### FEATURES:

- ▶ mass spectrometer ionisation energy control for soft ionisation of complex mixtures
- ▶ export data to NIST MS database for analysis of unknowns
- ▶ export to external data analysis software, e.g. Excel, Origin
- ▶ control of external devices, e.g. MFCs, gas switching/sampling valves and furnace PID controllers
- ▶ output data as percentage or ppm files
- ▶ real-time subtraction of overlapping peaks

# Hidden**APPLICATIONS**

Hidden's quadrupole mass spectrometer systems address a broad application range in:

## **GAS ANALYSIS**

- ▶ dynamic measurement of reaction gas streams
- ▶ catalysis and thermal analysis
- ▶ molecular beam studies
- ▶ dissolved species probes
- ▶ fermentation, environmental and ecological studies



## **SURFACE ANALYSIS**

- ▶ UHV TPD
- ▶ SIMS
- ▶ end point detection in ion beam etch
- ▶ elemental imaging – 3D mapping

## **PLASMA DIAGNOSTICS**

- ▶ plasma source characterisation
- ▶ etch and deposition process reaction kinetic studies
- ▶ analysis of neutral and radical species



## **VACUUM ANALYSIS**

- ▶ partial pressure measurement and control of process gases
- ▶ reactive sputter process control
- ▶ vacuum diagnostics
- ▶ vacuum coating process monitoring

# **HIDDEN**

**ANALYTICAL**

Hidden Analytical Ltd.  
420 Europa Boulevard  
Warrington WA5 7UN England

**T** +44 [0] 1925 445 225  
**F** +44 [0] 1925 416 518  
**E** [info@hidden.co.uk](mailto:info@hidden.co.uk)  
**W** [www.HiddenAnalytical.com](http://www.HiddenAnalytical.com)



### **Sales Offices:**

We have sales offices situated around the globe. **Visit our website for further information.**

